



Date: 07/20/2010

HC SERIES

MAIDA STYLE NUMBER R69ZOV151HC

MAIDA ITEM NUMBER 01-1883

VARISTOR SPEC SHEET

Electrical Specifications

Continuous AC Voltage	150	VAC
Continuous DC Voltage	200	VDC
Maximum DC Leakage @ 200 VDC	200	uA
Low Varistor Voltage Limit	212	VDC
High Varistor Voltage Limit	259	VDC
Nominal Varistor Voltage	235	VDC
Current for Varistor Voltage	1	mA
Maximum Clamp Voltage	395	V
Maximum Clamp Voltage Test Current	50	A
Peak Current Rating (1 Pulse)	9000	A
Peak Current Rating (2 Pulse)	7000	A
Energy Rating (8X20us)	78	J
Energy Rating (10X1000us)	78	J
Typical Capacitance	680	pF
Impulse Response Time	< 50	ns
Minimum Hipot of Coating	2500	VDC
Minimum I.R. of Coating	1000	MΩ
Current/Energy Derating Above 85°C	-2.5	%/°C

Thermal Specifications

Minimum Operating Temperature	-40	°C
Maximum Operating Temperature	85	°C
Varistor Voltage Temperature Coeff	-0.05	%/°C
Minimum Storage Temperature	-50	°C
Maximum Storage Temperature	125	°C
Recommended Solder Temperature	260	°C
Recommended Reflow Temperature	260	°C

Notes

Physical Specifications

Lead Style	082J1
X Nominal	0.3 in.
X Tolerance	0.04 in.
Y Nominal	0.129 in.
Y Tolerance	0.03 in.
Z Nominal	0.326 in.
Z Tolerance	0.04 in.
Lead Length Nominal	1.0 in.
Lead Length Tolerance	min. in.
d Nominal	0.032 in.
Wire Gauge	20 AWG
Minimum Marking	R69 HZ151
Nominal Disk Size	12 mm
D Maximum	0.566 in.
T Maximum	0.284 in.
H Maximum	0.691 in.
Coating Type	EPOXY

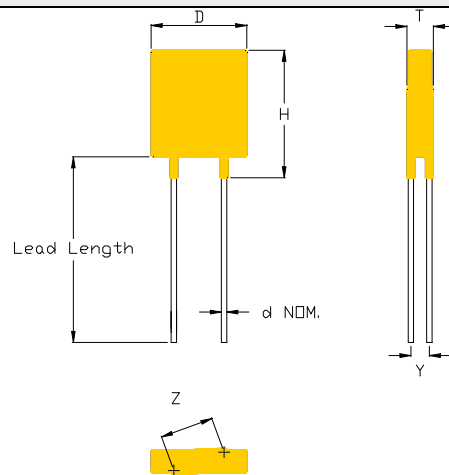

* Contact Maida for a more detailed configuration drawing.

Safety Agency Recognitions

UL 1449 File Number	E321173
- Tested to Type:	2
C-UL File Number	E321173
CSA File Number	
VDE File Number	
SEV File Number	



MAIDA DEVELOPMENT COMPANY
P.O. Box 3529
Hampton, Virginia 23663
Ph: (757) 723-0785 Fax (757) 722-1194

www.maida.com